



420 SERIES EXAMINATION TABLE MODELS 420 / 420-DW / 420-EO



INSTALLATION AND OPERATION MANUAL

420-INS-LAB-RevA20

Read this manual before installing or operating your Examination Table.

Save this manual for future use.

CONTENTS

1	INTRODUCTION.....	3
	INTENDED USE.....	3
	EQUIPMENT SYMBOL KEY.....	4
2	SAFETY PRECAUTIONS.....	5
	WARNINGS.....	5
3	FEATURES.....	7
	EXAM TABLE COMPONENTS.....	7
4	HANDLING PROCEDURES.....	8
	UNPACKING.....	8
	INSPECTION.....	8
	STORAGE.....	8
	DISPOSAL.....	9
5	INSTALLATION.....	10
	MODELS 420-DW AND 420-EO: INSTALLATION ELECTRICAL REQUIREMENTS.....	10
	MODELS 420-DW AND 420-EO: ELECTROMAGNETIC INTERFERENCE.....	10
	LEVELING THE EXAM TABLE.....	10
6	OPERATION.....	11
	EXAM TABLE BACK ANGLE RANGE.....	11
	PATIENT LEGREST AND PROCEDURE TRAY.....	12
	STIRRUP OPERATION.....	12
	PELVIC TILT OPERATION.....	13
7	CLEANING AND MAINTENANCE.....	14
	CLEANING.....	14
	MAINTENANCE.....	15
8	SPECIFICATIONS.....	16
9	LIMITED WARRANTY.....	17
10	INDEX.....	19

1 INTRODUCTION

Congratulations on your purchase of the Intensa 420 Series Examination Table. The following pages will provide you with important safety and operating instructions on the installation and operation of the Examination Table, as well as maintenance and warranty information. Read this manual carefully before operating your Examination Table and refer to it as often as needed. Consult your authorized distributor and / or healthcare professional with any questions or concerns regarding safe and effective techniques for operating your Examination Table.

This guide covers the use of the Intensa 420 Series Examination Table. Keep in mind that the basic safety procedures included in this manual are to be used as a guide only. You may find it necessary to develop your own unique methods for safely utilizing the Examination Table. Again, consult your healthcare professionals for their recommendations and never hesitate to ask for their assistance.

Upon receipt of the Examination Table, inspect it closely to ensure that nothing is damaged, there are no loose or broken parts, that all Examination Table parts are in the proper place, etc. Immediately replace any worn or broken components. Your Examination Table should receive maintenance on a regular schedule and should be inspected frequently for proper operation. Contact Intensa at 1.336.884.4096 with any maintenance concerns.

Info: Before attempting to install the Examination Table, refer to the section titled “INSTALLATION” contained elsewhere in this manual. Contact Intensa at 1.336.884.4096 if additional assistance is needed.





INTENDED USE

The Intensa 420 Series Examination Table is intended to support patients during medical examinations. During these exams, medical professionals use adjusting mechanisms to manipulate and position the table to provide patient support and closer examination of a portion of or the entire patient.

Contraindications for Models 420-DW and 420-EO

- ⚠ Warning: This equipment is not suitable for use in the presence of high flammable anesthetics or mixtures thereof and may result in serious injury or death.**
- ⚠ Warning: This equipment is not suitable for use in the presence of a highly oxygenated atmosphere and may result in serious injury or death.**
- ⚠ Warning: When this equipment is in use and a cauterization or high frequency surgical device is being used, the patient must be insulated from the metal table using a nonconductive material. Failure to do so could result in electrical shocks or burns to the patient.**

EQUIPMENT SYMBOL KEY

Symbol	Meaning
	Refer to Manual
	Shock Hazard
	Protective Earth Ground
	Shipping Orientation
	Maximum Weight Capacity 500 lb (317 Kg) Evenly Distributed

2 SAFETY PRECAUTIONS

IMPORTANT: Before installing or using Examination Table, read and then follow the following safety precautions and warnings. Failure to do so could result in serious personal injury or damage to your Examination Table.

Always consult your healthcare professional to determine safe methods most suitable for your individual abilities. Protect yourself, your attendant and Examination Table by having it serviced regularly. If you experience any malfunction, contact Intensa Tech Support at 1.336.884.4096 immediately, as a hazardous condition could result, causing personal injury or damage to your Examination Table.

Periodic inspection, adjustment and replacement of worn parts are necessary to provide years of excellent service. Refer to *CARE AND MAINTENANCE* section of this manual.

Maintenance **MUST** be performed by qualified personnel **ONLY**.

Significance of safety statements

Note the following special statements, used throughout this manual, and their significance:

- ⚠ DANGER:** Indicates a potential hazard situation or unsafe practice that, if not avoided, will result in death or serious personal injury.
- ⚠ WARNING:** Indicates a potential hazard situation or unsafe practice that, if not avoided, could result in death or serious personal injury.
- ⚠ CAUTION:** Indicates a potential hazard situation or unsafe practice that, if not avoided, could result in minor or moderate personal injury.
- ▲ NOTICE:** Indicates a potential hazard situation or unsafe practice that, if not avoided, could result in product or property damage.

Info: Provides application recommendations or other useful information to ensure that you get the most from your product.

WARNINGS

- ⚠ WARNING:** Important! Read and understand these instructions before assembling or using the Intensa 420 Series Examination Table. If you do not understand any part of these warnings, cautions or instructions, contact a healthcare professional for direction in the use of this product. If the Intensa 420 Series Examination Table is not properly assembled, personal injury and damage to the Examination Table could result.
- ⚠ WARNING:** If components are damaged or missing, contact Intensa immediately. **DO NOT** use substitute parts. Use only Intensa replacement parts. The use of non-Intensa replacement parts could cause personal injury, property damage, and void the warranty.
- ⚠ WARNING:** Unauthorized modification of your Examination Table could cause personal injury, property damage, and void the warranty.
- ⚠ WARNING:** The Intensa 420 Series Examination Table maximum weight capacity is 500 lb (227 kg), **EVENLY DISTRIBUTED**. **DO NOT** exceed the maximum weight capacity.
- ⚠ WARNING:** Intensa, Inc. assumes no responsibility for any damage or injury caused by improper assembly or use of this product.
- ⚠ WARNING:** Check all parts for shipping damage before using. In case of damage, **DO NOT USE** the equipment. Contact the carrier or Intensa for further instructions.

- ⚠ WARNING: Unauthorized modification of the Examination Table or the use of non-Intensa replacement parts may change the structure of the table and could create a hazardous condition, which may result in serious injury and void the warranty.**
- ⚠ WARNING: This product can expose you to chemicals including Di(2-ethylhexyl)phthalate (DEHP) which is known to the State of California to cause cancer and birth defects or other reproductive harm. For more information go to www.p65warnings.ca.gov/furniture.**
- ⚠ WARNING: Intensa, Inc. specifically disclaims responsibility for any bodily injury or property damage which may occur during any use which does not comply with federal, state or local laws or ordinances.**

3 FEATURES

EXAM TABLE COMPONENTS



4 HANDLING PROCEDURES



UNPACKING

⚠ **WARNING:** *This exam table, as shipped, can weigh as much as 330 lb (150 kg) – use sufficient personnel to lift and remove the exam table from the shipping pallet for placement into final location. DO NOT attempt to remove the exam table from the shipping pallet or move it without assistance. Use proper lifting technique, and see illustration above for proper lifting area; neglect of these procedures could result in serious injury.*

▲ **NOTICE:** Do Not Use a knife or other sharp object to open packaging – damage could occur to the exam table upholstery or surface.

1. Check for any obvious damage to the carton or its contents. If damage is evident, immediately notify the carrier or Intensa.
2. Carefully remove the exam table from the shipping pallet.

INSPECTION

1. Examine the Examination Table for nicks, dents, scratches or other damage. If damage is evident, immediately notify the carrier or Intensa.
2. Inspect all components.
3. If damage to any component is evident, immediately notify the carrier or Intensa.

STORAGE

Store the repackaged Examination Table in a dry area.

DISPOSAL

⚠ WARNING: During normal use of this product, it could become contaminated and may present a biohazard to waste sites.

This product may contain substances that could be harmful to the environment if disposed of in places (landfills) that are not appropriate according to local legislation.

At the end of this product's useful life, dispose of it in accordance with local requirements, or contact the manufacturer for advice. Recycle this product through your recycling facility or dispose of it in accordance with local regulations.

We recommend disassembling and dividing the equipment and components into different waste groups such as: metal, cable, electronic, recoverable resource and plastic for recycling or combustion. Most plastic components are provided with a plastic types code and fiber content to aid sorting of plastic parts.

5 INSTALLATION

- ⚠ **WARNING: Do Not Use Stirrups , Legrest Pull-Out or Upholstery to lift, move or slide the table. Personal injury and damage to exam table could occur.**
- ⚠ **WARNING: Unauthorized modification of the Examination Table may change the structure of the table and could create a hazardous condition, resulting in serious injury or death.**

MODELS 420-DW AND 420-EO: INSTALLATION ELECTRICAL REQUIREMENTS

- ⚠ **Warning: Use 115 VAC, 60 Hz. Failure to do so may result in electrical shock and may cause damage to the exam table.**
- ⚠ **Warning: The power cord and table must be set up for easy access and use, with no obstructions for the table to be unplugged.**
- ⚠ **Warning: This table must only be connected to a main supply with protective earth.**
- ⚠ **Warning: When connecting equipment to a courtesy outlet, this creates a “Medical Electrical System” which can result in a lowering of safety levels.**

MODELS 420-DW AND 420-EO: ELECTROMAGNETIC INTERFERENCE

This product is designed and built to minimize electromagnetic interference with other devices. If interference is noticed:

- Remove interfering device from the room.
- Plug exam table into an isolated circuit.

LEVELING THE EXAM TABLE

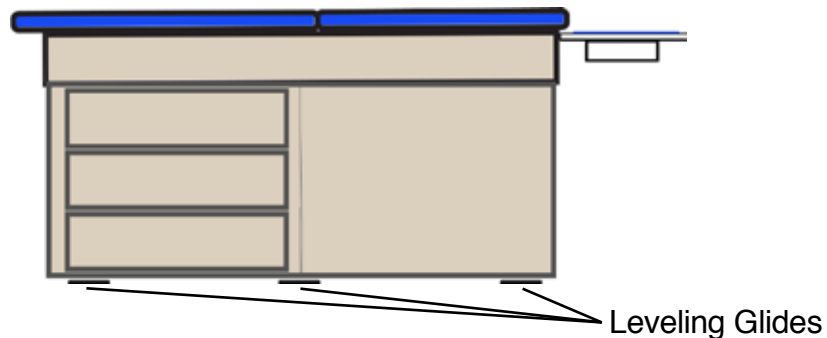

1. Locate Leveling Glides on Bottom of exam table base, shown above (six total).
2. Turn Leveling Glide counterclockwise to raise exam table.
3. Turn Leveling Glide clockwise to lower exam table.

6 OPERATION

EXAM TABLE BACK ANGLE RANGE

⚠ WARNING: This exam table is manually operated. Once the back reaches its maximum angle or a horizontal position, the back will stop moving. When the back is lowered, ensure hands or other objects are clear from the downward motion area.

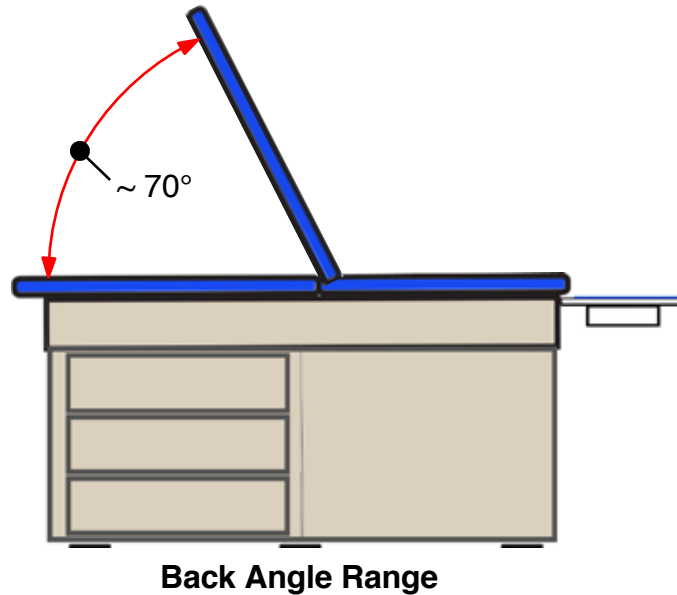

The exam table features a limited back angle of $\sim 70^\circ$ to accommodate heavier occupants comfortably, as shown above.

Back Angle Adjustment

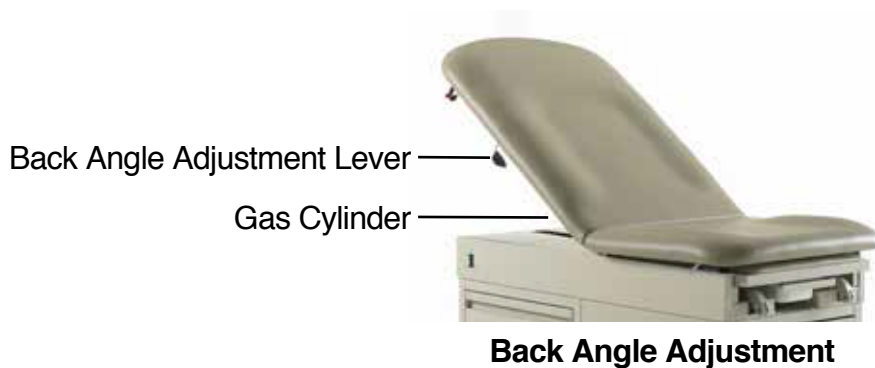

The back angle adjustment levers are located on both side of the back, as shown above

To raise the back: Pull the lever up and allow the back to rise until it is in the desired position. Release the lever to lock the gas cylinder and back in that position.

To lower the back: Pull the lever up and then push down on the upholstery to lower the back until it is in the desired position. Release the lever to lock the gas cylinder and back in that position.

⚠ WARNING: Ensure the back is locked in position before using exam table.

PATIENT LEGREST AND PROCEDURE TRAY

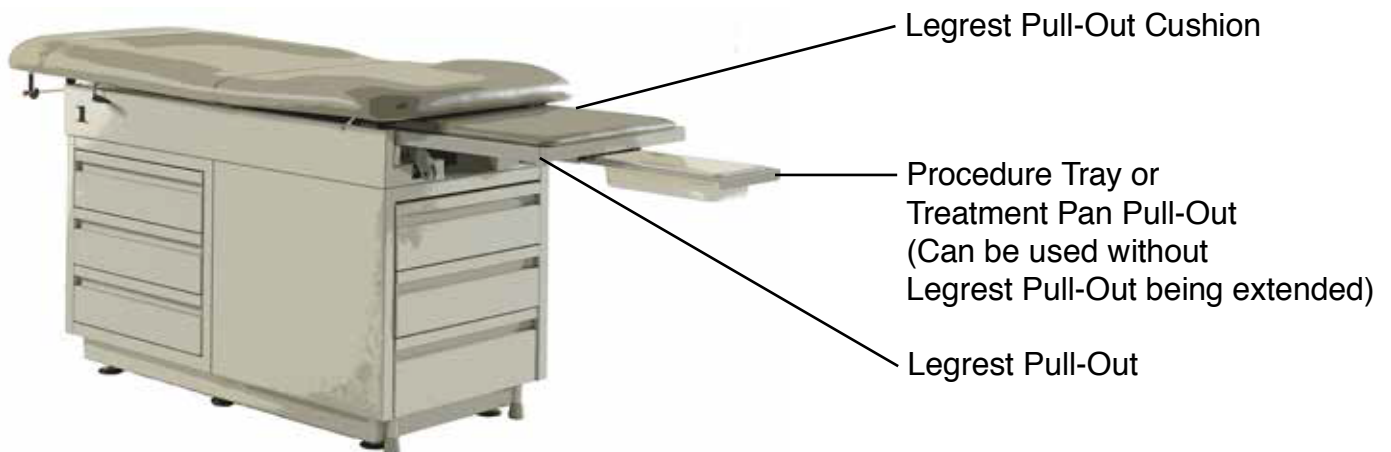

The Legrest Pull-Out, shown above, is located under the seat portion of the table cushion and can be extended 16 in. (41 cm). The Procedure Tray or Treatment Pan can be extended up to 13 in. (33 cm) and can be used independently of the Legrest Pull-Out. The Legrest Pull-Out cushion need not be removed to access the Procedure Tray.

STIRRUP OPERATION

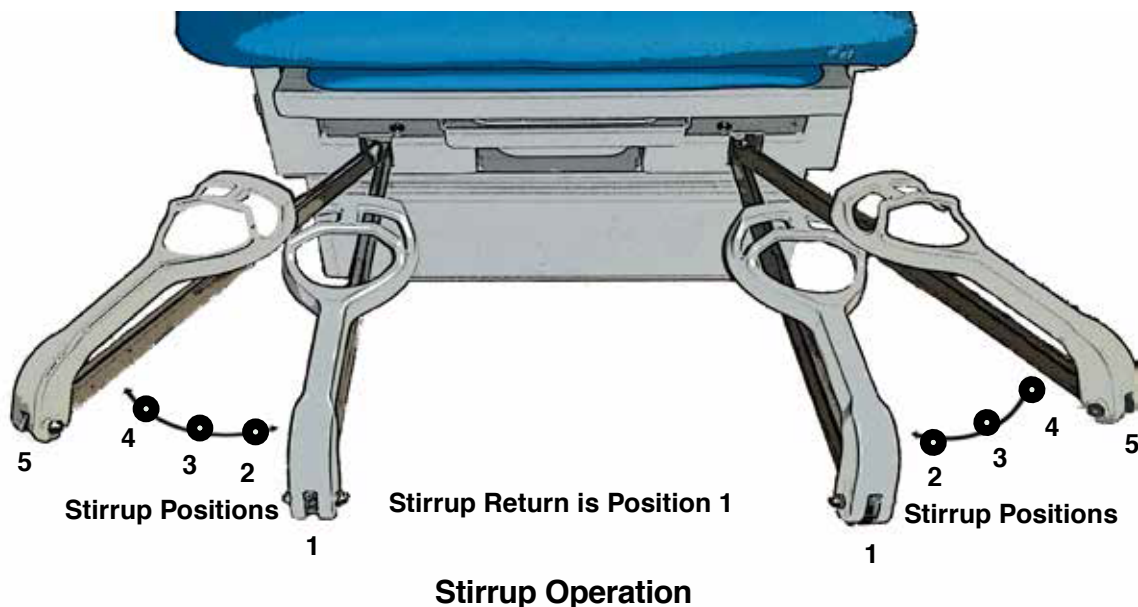

⚠ WARNING: Ensure stirrups are locked in place before use. Stirrups will not support entire patient weight.

1. Pull Stirrup straight out and unfold heel portion.
2. To move stirrups left and right, lift slightly and move to desired location.
3. Press down to lock stirrup into one of the available five positions as shown above.

PELVIC TILT OPERATION



Pelvic Tilt Down Position



Pelvic Tilt Up Position

- 1.. Lift seat portion of upholstery to raise and lower pelvic tilt, as shown above.
2. Once pelvic tilt is in desired position, lower the seat.

7 CLEANING AND MAINTENANCE

▲ **NOTICE – POSSIBLE EQUIPMENT DAMAGE HAZARD:** Steam cleaning and pressure washing of exam table is not recommended and may void warranty.

⚠ **WARNING:** Service and repair of the Intensa 420 Series Examination Table **MUST** be performed by qualified personnel **ONLY**.

⚠ **WARNING:** Unauthorized modification of the Examination Table or the use of non-Intensa replacement parts may change the structure of the table and could create a hazardous condition, which may result in serious injury and void the warranty.

Info: For more detailed information, please contact Intensa at 1.336.884.4096.

CLEANING

▲ **NOTICE:** DO NOT wash Examination Table under water pressure or steam clean.

▲ **NOTICE:** Cleaning solvents, dyes or sharp objects can damage upholstery. Promptly remove any excess fluids and rinse surface with clean water and wipe surface dry. Clean your upholstered top weekly. For basic cleaning use mild soap and water, rinse thoroughly and wipe surface dry.

Perform the following cleaning procedures as scheduled:

Component	Cleaning Procedure	Schedule	Cleaning Agent *	Special Notes
Pads	Wipe with damp cloth to remove any foreign material	After each use	Routine hospital grade disinfectants, soap and water	Use only medium strength cleaners Do not steam clean or pressure wash
Exam table	Wipe with damp cloth to remove any foreign material	After each use	Routine hospital grade disinfectants, soap and water	Lubricate pivot points after cleaning
Models 420-DW and 420-EO only:				
Electrical components	Wipe external surfaces ONLY with damp cloth to remove any foreign material	After each use	Routine hospital grade disinfectants, soap and water	Use only medium strength cleaners

* Disinfecting and Cleaning Upholstery - ALWAYS follow manufacturer's recommended dilution	
Disinfectants for vinyl products	Phenolic disinfectants are the best choice for vinyl
	Properly diluted quaternaries are also acceptable for vinyl
	Quaternary / Isopropyl disinfectants ARE NOT recommended for vinyl
Disinfectants for urethane products	Quaternary disinfectants are recommended for urethane
	Quaternary / Isopropyl disinfectants are recommended for urethane
	Phenolics SHOULD BE AVOIDED on urethane
Disinfectants for all products	All fabrics may be cleaned with a 1:10 dilution of household bleaches containing 5.25% sodium hypochlorite as recommended by the Centers for Disease Control in Atlanta, Georgia; there is no harmful effect on the fabric
	Disinfectants applied at full concentration or in highly concentrated solutions will decrease the useful life of fabric
	Iodophor-type disinfectants used on fabric may result in staining

* Disinfecting and Cleaning Upholstery continued	
Soils or Stains	Use neutral soapsuds and lukewarm water; DO NOT use harsh cleansers, solvents or detergents
Hard-To-Clean Spots	Use standard household / vinyl cleansers and a soft bristle brush on troublesome spots or stains; presoak heavy, dried-on soil
Laundering	Laundering Vinyl-laminated, Polyurethane-coated, or Rubber-coated fabric IS NOT recommended; laundering may substantially decrease the useful life of the fabric

MAINTENANCE

Have a qualified service technician perform the following maintenance as scheduled:

Maintenance Procedure	Schedule	Materials / Action Required
Inspect all mechanical functions for good operation	Every 3 months	If replacement is needed, contact Intensa at 1.336.884.4096
Examine power cord for wear and function		Examine for external wear, cuts, or wear. If replacement is needed, contact Intensa at 1.336.884.4096
Inspect all fasteners to ensure proper fit, position and tightness (including nuts, bolts, etc.)		Proper size wrench and screwdriver
Lubricate all moving and sliding parts and hinge points		Lubricating oil, light-duty grease, wax stick lubricant or Never-Seez lubricant
Inspect all surfaces and remove any sharp or burred areas; apply touch-up paint where required		Metal file, proper color paint (specify color when ordering)

⚠ WARNING: After performing maintenance, when you believe a component or part is not functioning properly, immediately contact Intensa at 1.336.884.4096, as a potentially hazardous condition could exist.

8 SPECIFICATIONS

Exam Table Weight	Model 420	Product Weight	275 lb (125 kg)
		Shipping Weight	325 lb (147 kg)
	Model 420-DW	Product Weight	280 lb (127 kg)
		Shipping Weight	330 lb (150 kg)
	Model 420-EO	Product Weight	280 lb (127 kg)
		Shipping Weight	330 lb (150 kg)
Load Rating (Evenly Distributed)		500 lb (227 kg)	
Legrest Support Maximum Weight Capacity		50 lb (23 kg)	
Foot Step Support Maximum Weight Capacity		800 lb (363 kg)	
Table Height		32 in. (81 cm)	
Back Angle Range		0° to ~70°	
Upholstered Top Size (W x L)		27 in. x 60 in. (69 cm x 152 cm)	
Upholstered Leg Support Pad Size (W x L)		18 in. x 19.5 in. (46 cm x 49.5 cm)	
COM (Customer's Own Material) Requirements		3 yd. (2.74 m)	
Overall Bed Length		60 in. (152 cm)	
Overall Bed Length with Leg Extension		72 in. (183 cm)	
Drawer Size (W x L x D)	3 Pass Through Drawers	18 in. x 20.5 in. x 4 in. (46 cm x 52 cm x 10 cm)	
	2 Storage Drawers	17 in. x 17.5 in. x 4 in. (43 cm x 44 cm x 10 cm)	
Electrical Requirements	420	N/A	
	420-DW	115-250 VAC	
	420-EO		
Power Cord (Models 420-DW / 420-EO ONLY)	Length (from table)	90 in. (229 cm)	
	Specifications	300V / 18AWG/ 3 Conductor/ SJT Jacket with Hospital Power Cord	
Drawer Warmer (optional) temperature		Will heat area approximately 97°-99°	
Paper Roll Sizes (W x Roll Diameter)		18 in. x 3 in. (46 cm x 8 cm)	
		19 in. x 3 in. (48 cm x 8 cm)	
		21 in. x 3 in. (53 cm x 8 cm)	
Transport and Storage Conditions	Temperature Range	-20°F to 150°F (-29°C to 66°C)	
	Relative Humidity	10% to 90%	
Operating Conditions	Temperature Range	65°F to 85°F (18°C to 29°C)	
	Relative Humidity	10% to 90%	

9 LIMITED WARRANTY

SCOPE OF WARRANTY

Intensa, Inc. (“Intensa”) warrants to the original purchaser only that it will replace or repair components, at Intensa’s sole discretion, that are defective in material or workmanship under normal use and service. All warranties are conditioned upon the proper use of the products strictly in accordance with good commercial practice and applicable Intensa instructions and manuals, including proper use and maintenance. To the extent that a component is warranted by a third party, Intensa conveys all of its rights under that warranty to the original purchaser, to the extent permitted. This limited warranty shall only apply to defects that are reported to Intensa’s customer service team within the applicable warranty period and which, upon examination by Intensa or its authorized representative, prove to be a warranty item. This limited warranty is not transferable. Within the guidelines set forth in this document, the following components are warranted for the time period set forth below:

Examination Table Components: *

Base:	5 years
Electronic Components:.....	2 years
Mechanical Components:.....	3 years
Original and Replacement Upholstered Tops †:.....	1 year
Replacement Parts ‡:.....	90 days

* Labor is not included in the warranty.

† Upholstery is only warranted on material supplied by Intensa.

‡ The warranty period is as designated above. If a part is replaced under warranty, the original warranty period will not be affected. All other replacement parts will be subject to the warranty period specified.

The applicable warranty period shall commence from date of shipment to the original customer, unless there is an expiration date on the component in which case the warranty shall expire on the earlier of warranty period or the expiration date.

OBTAINING WARRANTY SERVICE

This limited warranty shall only apply to defects that are reported to the Distributor from whom the Customer purchased the product within the applicable warranty period. If there is not a Distributor, you must contact Intensa directly by calling 1.336.884.4096, or by e-mailing a request to intensa@grahamfield.com. Specific directions will be provided by the Customer Service Representative. Failure to abide by the specific directions will result in denial of the warranty claim.

EXCLUSIONS

The warranty does not cover and Intensa shall not be liable for the following:

- 1) Defects, damage, or other conditions caused, in whole or in part, by misuse, abuse, negligence, alteration, accident, freight damage, tampering or failure to seek and obtain repair or replacement in a timely manner;
- 2) Products which are not installed, used, or properly cleaned and maintained as required in the official manual for the applicable product;
- 3) Products considered to be of a non-durable nature including, but not limited to: tips, casters, filters, fuses, gaskets, lubricants, and charts;

- 4) Accessories or parts not provided by Intensa;
- 5) Matching of color, grain or texture except to commercially acceptable standards;
- 6) Changes in color caused by natural or artificial light;
- 7) Charges by anyone for adjustments, repairs, replacement parts, installation or other work performed upon or in connection with such products which are not expressly authorized in writing, in advance, by Intensa;
- 8) Any labor or shipping charges incurred in the replacement part installation or repair;
- 9) Costs and expenses of regular maintenance and cleaning; and
- 10) Representations and warranties made by any person or entity other than Intensa.

ENTIRE WARRANTY, EXCLUSIVE REMEDY AND CONSEQUENTIAL DAMAGES DISCLAIMER

THIS WARRANTY IS INTENSA'S ONLY WARRANTY AND IS IN LIEU OF ALL OTHER WARRANTIES, EXPRESS OR IMPLIED. INTENSA MAKES NO IMPLIED WARRANTIES OF ANY KIND INCLUDING ANY IMPLIED WARRANTIES OF MERCHANTABILITY OR FITNESS FOR A PARTICULAR PURPOSE. IF ANY MODEL OR SAMPLE WAS SHOWN TO THE CUSTOMER, SUCH MODEL OR SAMPLE WAS USED MERELY TO ILLUSTRATE THE GENERAL TYPE AND QUALITY OF THE PRODUCT AND NOT TO REPRESENT THAT THE PRODUCT WOULD NECESSARILY CONFORM TO THE MODEL OR SAMPLE IN ALL RESPECTS. THIS WARRANTY IS LIMITED TO THE REPAIR OR REPLACEMENT OF THE DEFECTIVE PARTS. INTENSA SHALL NOT BE LIABLE FOR AND HEREBY DISCLAIMS ANY DIRECT, SPECIAL, INDIRECT, INCIDENTAL, EXEMPLARY OR CONSEQUENTIAL DAMAGES, INCLUDING, BUT NOT LIMITED TO: DAMAGES FOR LOSS OF PROFITS OR INCOME, LOSS OF USE, DOWNTIME, COVER, OR EMPLOYEE OR INDEPENDENT CONTRACTOR WAGES, PAYMENTS AND BENEFITS. CERTAIN STATES MAY CONFER ADDITIONAL RIGHTS REGARDING WARRANTIES AND IN THOSE STATES INTENSA'S LIABILITY AND THE LIABILITY OF INTENSA'S SUPPLIERS, SHALL BE LIMITED TO THE FULLEST EXTENT PERMITTED BY LAW.

The warranties contained herein, together with Intensa's current Terms and Conditions, contain all the representations and warranties with respect to the subject matter of this document, and supersede all prior negotiations, agreements and understandings with respect thereto. The recipient of this document hereby acknowledges and represents that it has not relied on any representation, assertion, guarantee, warranty, collateral contract or other assurance, except those set out in this document.

For additional information on these products or this warranty, please contact an Intensa Customer Service Representative.

NOTES:

- 1) Additional terms and conditions may apply. See Intensa's General Terms and Conditions on its website and the specific warranties, which may accompany the specific product.
- 2) Freight claims must be notated on the appropriate shipping documents and must be made with immediacy. International, federal and state regulations govern specific requirements for freight claims. Failure to abide by those regulations may result in a denial of the freight claim. Intensa will assist you in filing the freight claim.
- 3) Claims for any short shipment must be made within three (3) days of the invoice date.

10 INDEX

B

Back angle adjustment 11
Back angle range 11

C

CAUTION statement, significance 5
Cleaning 14
Cleaning and maintenance 14
Contraindications to intended use 3

D

DANGER statement, significance 5
Disposal 9

E

Electrical requirements, installation 10
Exam table components 7

F

Features 7

H

Handling Procedures 8

I

Info statement, significance 5
Inspection 8
Installation 10
Intended use 3
Introduction 3

L

Legrest and procedure tray 12
Leveling glides 10
Leveling the exam table 10
Lubrication 15

M

Maintenance 15

N

NOTICE statement, significance 5

O

Operation 11

P

Pelvic tilt operation 13

S

Safety precautions 5
Safety statements, significance of 5
Specifications 16
Stirrup operation 12
Storage 8
Symbol key, equipment 4

U

Unpacking 8

W

Warnings 5
WARNING statement, significance 5
Warranty, limited 17
Weight capacity, maximum 5



© 2020, Intensa, Inc. All Rights Reserved.
Intensa is a Wholly Owned Subsidiary of
GF Health Products, Inc.

Manufactured by:
Intensa, Inc.
1810 S. Elm St.
High Point, NC 27260

1.336.884.4096
intensa@grahamfield.com
intensa.net

Made in U.S.A.